

# 25/93

## BOTOLA

ROOF HATCH

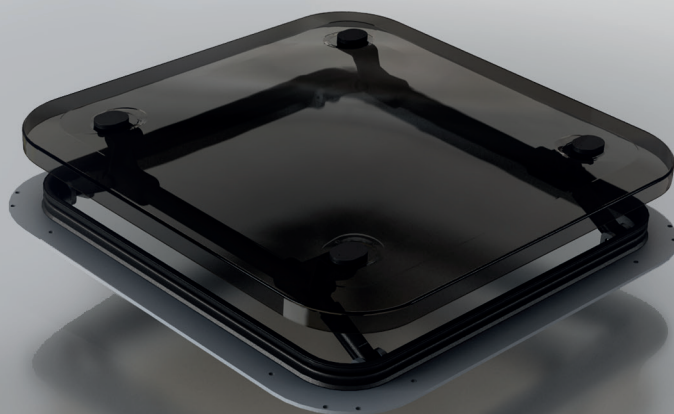

### CARATTERISTICHE STANDARD

- Applicazione: Aerazione;
- Dispositivi di apertura: 2 manuali in alluminio anodizzato e tecnopolimeri stampati;
- Dimensioni d'ingombro telaio: 505x505 mm;
- Coperchio standard in metacrilato termoformato semitrasparente;
- Telaio di fissaggio in materiale plastico PA.

### STANDARD FEATURES

- Application: Ventilation;
- Opening device: 2 manual arms in anodized aluminum and injected techno-polymers;
- Roof-aperture for assembly frame: 505x505 mm;
- Standard dome in thermoformed semitransparent metacrylate;
- Assembly frame in plastic.





**SCARICA LA SCHEDA TECNICA**  
DATASHEET DOWNLOAD

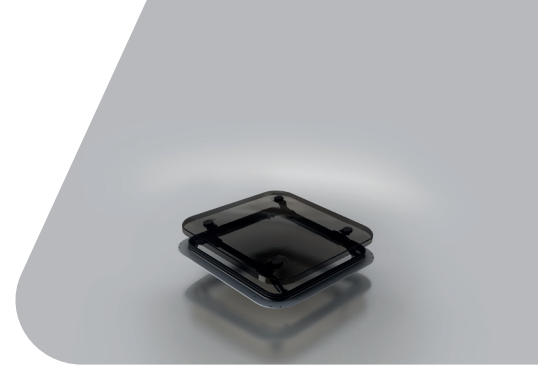

**DIMENSIONI SEDE PER BOTOLA**  
Size for hatch housing

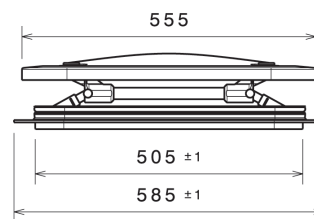
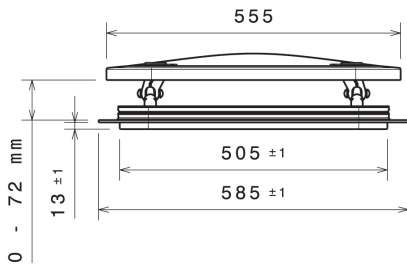
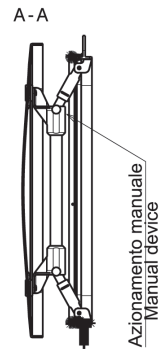
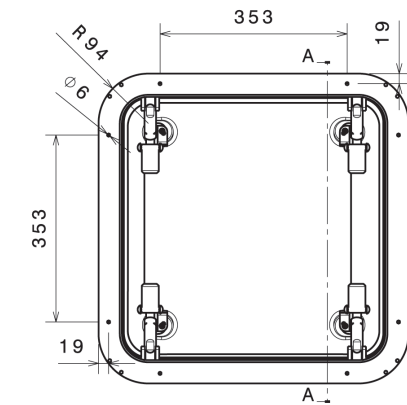
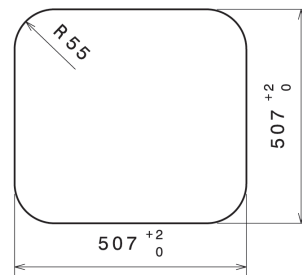
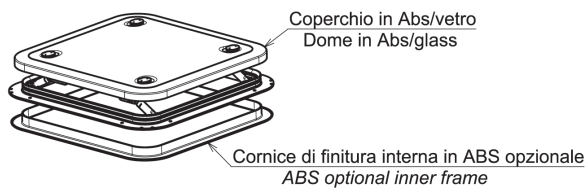

LAM S.p.A.  
Via Guido Rossa, 4 - 41057 Spilamberto (MO) - Italy  
Tel. +39 059 784392 - Fax +39 059 8638048  
[www.lamspa.it](http://www.lamspa.it)

ISO 9001:2015  
IATF 16949:2016

